



**PFAFF** Industrial  DÜRKOPP  
ADLER

**JEANS**  **MACHINES**

PREMIUM RANGE



Advanced sewing solutions  
for processing jeans



# JEANS - Growth potential of a Classic

Jeans are timeless – however, their production has for decades been subject to a highly dynamic environment. The growth potential for this product (mainly jeans) is still strong. Around the world more than 4,5 billion pairs of jeans are being sold each year. Until 2020 the market will experience further significant growth. A positive growth development is expected on all continents – in Asia, the most populous continent, the highest growth rates are anticipated. A modified market situation that becomes increasingly similar to western consumer pattern indicates that the demand for medium and high-priced jeans will rise.

Throughout the entire textile industry the demand is increasing for automated solutions which ensure good and consistent quality with high-performance (output). This requirement for automated production will further intensify due to limited resources and rising wages in the current production countries. The jeans industry offers a huge potential for investment.

Using the unique know-how within the Shanggong Group and an extremely strong sales organization with partners in virtually all countries, we want to sustainably grow the jeans segment under the auspices of PFAFF Industrial. In the mid-term we want to become the leaders both in terms of technology and market share with new and capable products.

<b>Jeans solutions</b>	<b>Page</b>
2081/2083 C	4
2081/2083-731	5
281-160362-03	6
2542 Plus	7
827-160122-M	8
827-260122-M	9
867-190040-M	10
867-290040-M	11
1246	12
3713	13
868-190322-M	14
5483-814/06-94/01 BS x6,0	15
5489-H ...-58/05	16
5622	17
5626	18
512-211-01	19
581-141 CLASSIC	20

581-341 MULTIFLEX	21
581-141 CLASSIC INDEXER	22
3511	23
739-23-01	24
3719	25
3819	26
3538	27
3840	28
3588-05/020 ...-15/020	29
3589	30
806N-111-01	31
906-01	32
906-TUP-BRI	33
906-TUP-Quadri	34
1222-5-1	35
1280-5-1	36
Technical Symbols	37-39

581-141 Classic  
 581-141 Indexer  
 581-341 Multiflex

3538

3588  
 2542 Plus  
 2081 C

827-160122-M (multi-thread)



512-211-01 (heavy)

3840

5483 ...-94/01

3819/3719  
 5626

2081-731 / 2083-731  
 2081 C  
 281-160362-03

2081-731 / 2083-731  
 2542

827-260122-M (multi-thread)

3511 (for flaps)  
 739-23-01 (for flaps)

827-160122-M  
 (multi-thread)



5622

5489-H

3538

3588  
 3589  
 806N-111-01  
 906-01  
 906-TUP-BRI  
 906-TUP-Quadri

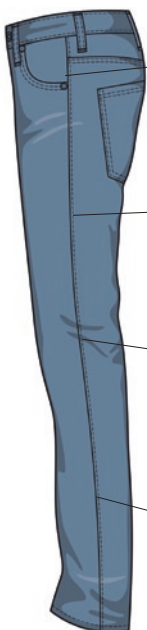

3713  
 868-190322-M

Optional (1-needle top-stitching)

2081 C  
 827-160122-M  
 867-190040-M

Optional (2-needle top-stitching)

1246  
 2542  
 827-260122-M  
 867-290040-M

1222-5-1  
 1280-5-1 (heavy)

XXX **PFAFF**<sup>®</sup> Industrial

XXX **DURKOPP ADLER**

XXX **beisler**  
 SEWING



## Single-needle highspeed seamer with drop feed or compound feed

- For 50 years “dry machine” (no oil sump)
- Good stitch length continuity and seam quality
- Large hook (G) with 50 % more capacity than conventional hooks (Option)
- High flexibility due to the adjustable needle bar stroke (30.0 to 36.0 mm):  
One machine for all material thicknesses
- Eccentric for tilted position of the feed dog
- Large clearance under machine arm (300 mm)
- Knife/catcher change on thread trimmer without readjustment
- Integrated solutions for presser foot lift, backtacking mechanism without compressed air
- Stitch length up to 6 mm – forwards and reverse (on the PFAFF 2081/83 C-Version)
- -909/14: Thread pulling device for neat seam start with thread clamp (Option)
- Option: Oil free sewing – by simply changing the hook (max. speed: 4,000 s.p.m.)

### Typical field of application

#### 2081:

- Topstitching seams

#### 2083:

- General operations in most different garment sectors

### Specifications

- Max. stitch length: 6.0 mm
- Max. speed: 5,500 s.p.m.
- Clearance under sewing foot: 13.0 mm

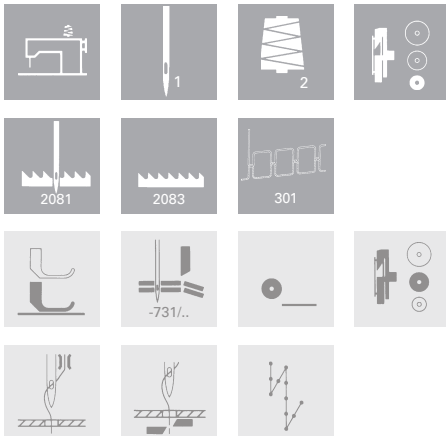



## Single-needle highspeed seamer with drop feed or compound feed and edge trimmer

- For 50 years “dry machine“ (no oil sump)
- Good stitch length continuity and seam quality
- Large hook (G) with 50 % more capacity than conventional hooks (Option)
- High flexibility due to the adjustable needle bar stroke (30.0 to 36.0 mm):  
One machine for all material thicknesses
- Eccentric for tilted position of the feed dog
- Large clearance under machine arm (300 mm)
- Knife/catch change on thread trimmer without readjustment
- Integrated solutions for presser foot lift, backtacking mechanism without compressed air
- Stitch length up to 6 mm – forwards and reverse (on the PFAFF 2081/83 C-Version)
- -909/14: Thread pulling device for neat seam start with thread clamp (Option)
- Option: Oil free sewing – by simply changing the hook (max. speed: 4,000 s.p.m.)

### Typical field of application

- Seams with neatly cut edges

### Specifications

- Max. stitch length: 6.0 mm
- Max. speed: 5,500 s.p.m.
- Clearance under sewing foot: 13.0 mm

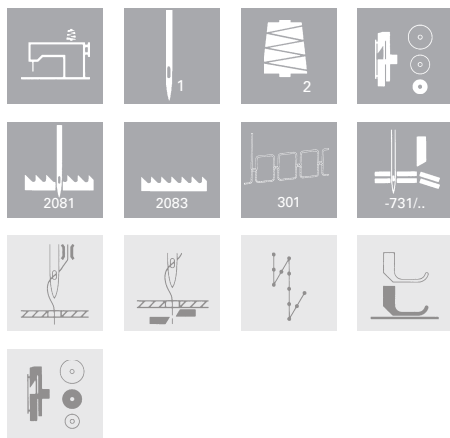



## Single-needle highspeed seamer with drop feed

- DAC basic control
- Semi-Dry-Head, oil-free machine head; only the hook is lubricated
- Convenient adjustment of the sewing foot pressure without any tools
- Neat seam beginning by means of thread nipper
- Integrated electromagnets for all functions, without compressed air
- Standard automatic backtacking and thread Trimming

### Typical field of application

- Universal use in all sectors of outerwear,
- sportswear, workwear and jeans for medium to
- heavy-weight material

### Performance features

- Max. sewing foot lift 16 mm
- Max. stitch length 6 mm
- Needle size: Nm 90 –130
- Max. sewing speed 4,000 stitches/min.

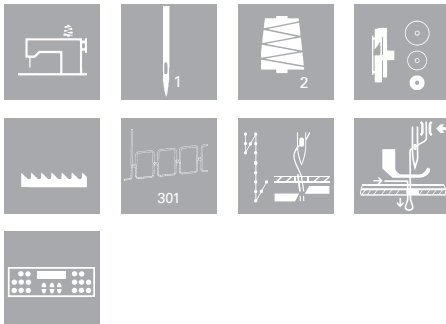



## Double-needle special sewing machine with compound feed for medium to heavy-weight materials

- Excellent seam quality for a wide spectrum of application
- Programmable multi switch in easy reach of the operator
- Large clearance under machine arm (345.0 x 120.0 mm)
- Bobbin winder for a secure and fast start of the winding process („winding assistant“)
- Bobbin thread monitoring (option)
- Automatic presser foot lifting, backtacking and thread trimming with thread ends < 13 mm
- Two pre-selectable stitch length, alternately switchable

### Typical field of application

- Two-needle top-stitching operations

### Specifications

- Max. sewing speed: 3,800 s.p.m.
- Max. stitch length: 9.0 mm
- Needle gauge: 3.2 - 70 mm

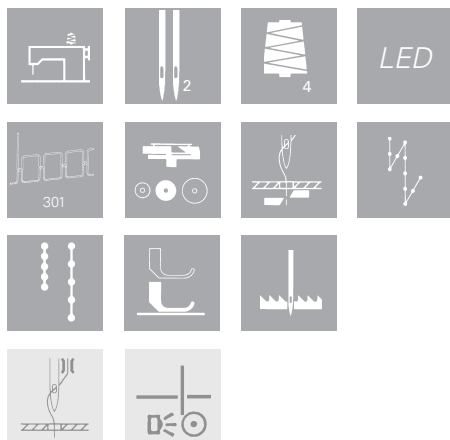



## Single-needle sewing machine with compound feed for multi-thread decorative topstitching seams

- Integrated direct drive with DAC classic control
- Up to 7 mm long stitches for decorative seams
- Fashionable – even multi-coloured – decorative seams by simultaneous sewing with multiple needle threads
- Thread trimmer for thread sizes up to Nm 20/3 respectively 5 x Nm 80/3
- Excellent stitch pattern due to constantly tight stitch formation
- Powerful and effective feeding system with bottom and needle feed for displacementfree material feed, even when sewing over transversal seams
- The sewing foot stroke of up to 16 mm facilitates feeding and removing of workpieces
- The large clearance (335 mm wide and 125 mm high) facilitates the handling of large-area workpieces

### Typical field of application

- Decorative topstitching in the production of jeans, sportswear and coats

### Performance features

- Max. sewing foot lift 16 mm
- Max. stitch length 7 mm
- Needle sizes: Nm 80 – 130
- Max. sewing speed 3,800 stitches/min.
- Needle gauge: 3.0 - 50 mm

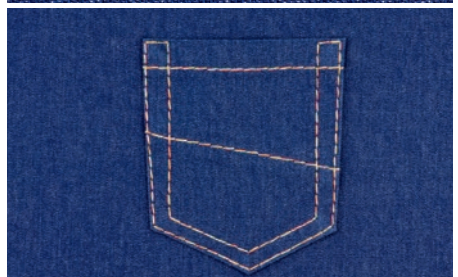
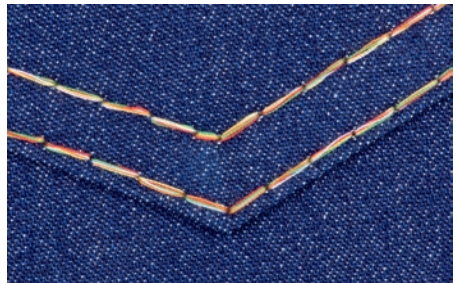
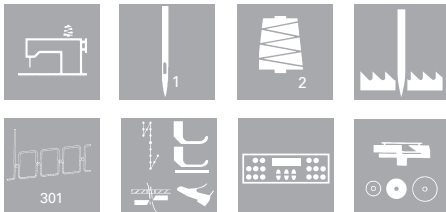





## Multi-thread double-needle sewing machine with compound feed for decorative topstitching seams

- Integrated direct drive with DAC classic control
- Up to 7 mm long stitches for decorative seams
- Fashionable – even multi-coloured – decorative seams by simultaneous sewing with multiple needle threads
- Thread trimmer for thread sizes up to Nm 20/3 respectively 5 x Nm 80/3
- Excellent stitch pattern due to constantly tight stitch formation
- Powerful and effective feeding system with bottom and needle feed for displacementfree material feed, even when sewing over transversal seams
- The sewing foot stroke of up to 16 mm facilitates feeding and removing of workpieces
- The large clearance (335 mm wide and 125 mm high) facilitates the handling of large-area workpieces

### Typical field of application

- Decorative topstitching in the production of jeans, sportswear and coats

### Performance features

- Max. sewing foot lift 16 mm
- Max. stitch length 7 mm
- Needle gauge: 3.0 - 50.0 mm
- Needle sizes: Nm 80 – 130
- Max. sewing speed 3,800 stitches/min.

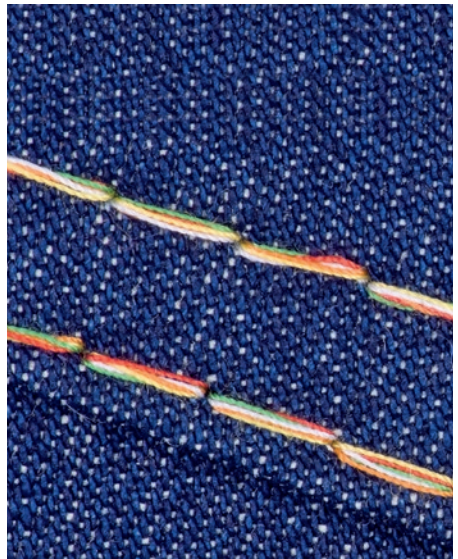
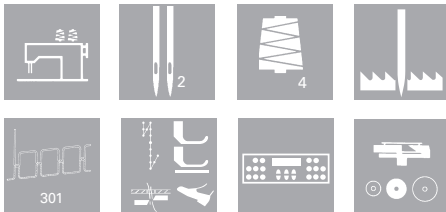

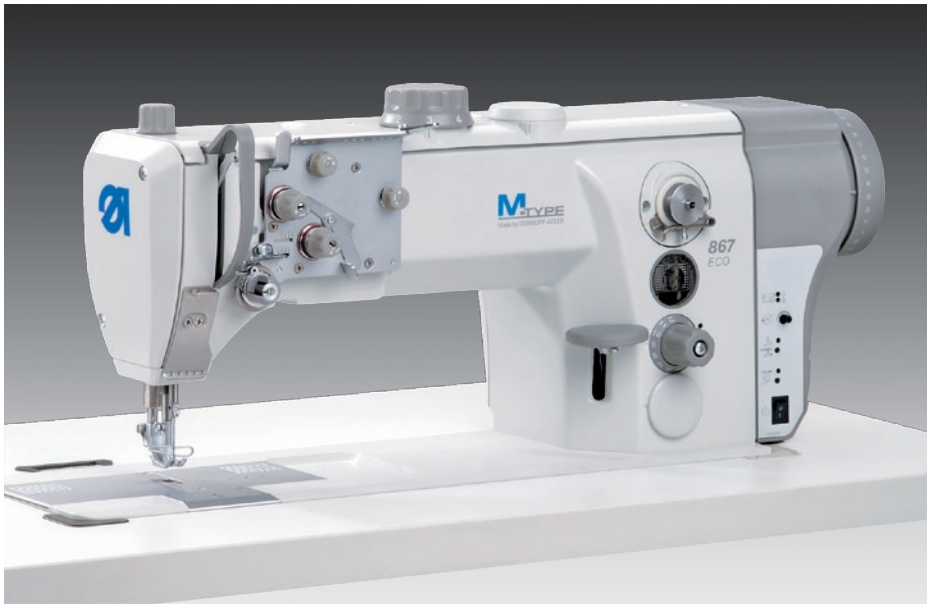

## M-TYPE 867-M ECO with XXL hook Single-needle special sewing machine with unison feed

- Integrated direct drive with DAC eco M-TYPE control
- The powerful and effective feeding system with bottom feed, needle feed and alternating top feed guarantees trouble-free and displacement-free material feed
- The extremely high sewing foot lift up to 20 mm facilitates the feeding and removing of bulky workpieces
- The high top feed stroke up to 9 mm allows a safe climbing over differently high material plies
- Excellent view on the sewing area
- Increased productivity due to the XXL hook (70% larger bobbin capacity in comparison to the standard hook)
- Complete range of sewing equipment, attachments and optional equipment, i.e. optimum equipment for nearly all sewing operations
- Also available with L-hook (867-190020-M)

### Typical field of application

- Universal sewing operations in the production of jeans, sportswear and coats

### Performance features

- Max. stitch length 12 mm
- Max. sewing speed 3,400 stitches/min.

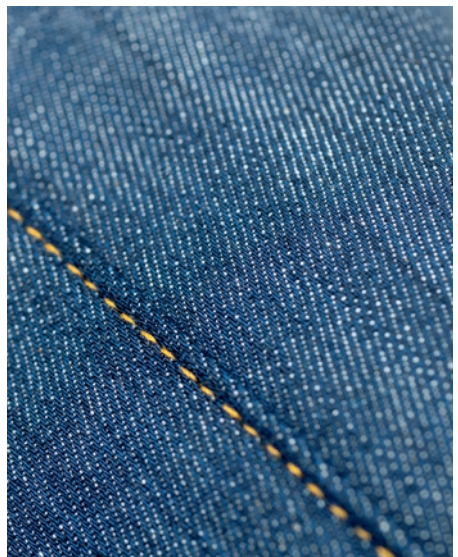
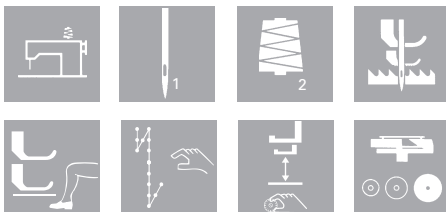



## **M-TYPE 867-M ECO double-needle with XXL hook** **Double-needle special sewing machine with unison feed**

- Integrated direct drive with DAC eco M-TYPE control
- The powerful and effective feeding system with bottom feed, needle feed and alternating top feed guarantees trouble-free and displacement-free material feed
- The extremely high sewing foot lift up to 20 mm facilitates the feeding and removing of bulky workpieces
- The high top feed stroke up to 9 mm allows a safe climbing over differently high material plies
- Excellent view on the sewing area
- Increased productivity due to the XXL hook (70% larger bobbin capacity in comparison to the standard hook)
- Complete range of sewing equipment, attachments and optional equipment, i.e. optimum equipment for nearly all sewing operations
- Also available with L-hook (867-190020-M)

### **Typical field of application**

- Universal sewing operations in the production of jeans, sportswear and coats

### **Performance features**

- Max. stitch length 12 mm
- Needle gauge: 3.0 - 50.0 mm
- Max. sewing speed 3,400 stitches/min.

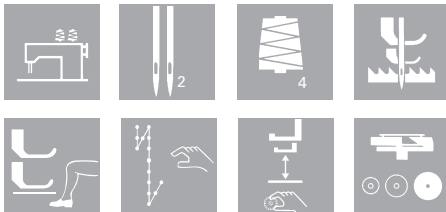



## Double-needle special sewing machine with unison feed and large vertical hook

- High traction due to unison feed
- Even feed motion without any ply-shift of individual layers
- Large vertical rotary hook with 60% more capacity than other standard-sized hooks
- Rugged and durable machine concept
- The high top feed lift (7.0 mm) allows trouble-free sewing of thick materials and an easy sewing over cross seams
- Easy loading and unloading (even bulky material) due to a high fabric clearance of 14.0 mm
- Attachment and extras for many further operations comprise, e. g.: welting operations, zipper operations, binding operations

### Typical field of application

- Universal double-needle top-stitching operations on jeans

### Specifications

- Max. sewing speed: 2,800 s.p.m.
- Max. stitch length: 8.0 mm

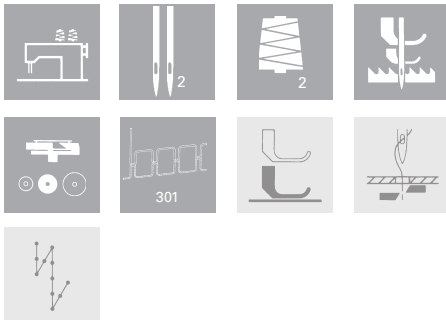



## Ergonomically designed standing workplace for oversteitching side seams

- Easy handling - the post- bed makes it easier to work the seams of the trousers when assembled
- While working in a standing position the bigger handling area optimizes freedom to pick work up and put it down
- Efficient working with rest board, double sided guidance at the sewing foot as well as seam program
- Seams are joined with effortless ease owing to unison feed
- Special parts set (with sewing feet) for left/right

### Typical field of application

- Oversteitching side seams around the hip curve

### Specifications

- Max. sewing speed: 2,600 s.p.m.
- Max. stitch length: 6.0 mm
- Output in 8h: approx. 1500 pairs of trousers

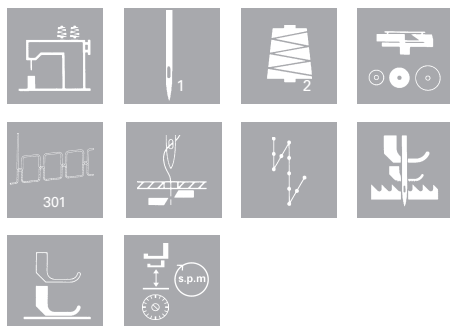



## Topstitching jeans side seams in the hip area

- Integrated direct drive with DAC classic con
- Lockstitch post bed machine with bottom feed, needle feed and alternating top feed for constant stitch lengths and trouble-free material feed
- Quick stroke adjustment with automatic speed limitation for sewing over transversal seams without loss of stitch length
- Excellent climbing properties and high needle penetration power guarantee easy sewing over transversal seams
- Tight stitch formation at problematic thick spots with switchable second needle thread tension
- High sewing foot lift for unhindered feeding and removing of workpieces

### Typical field of application

- Topstitching of side seams in jeans, workwear and functional clothing

### Performance features

- Max. sewing speed 2,500 stitches/min
- Max. stitch length 12 mm
- Max. thread size Nm 10/3

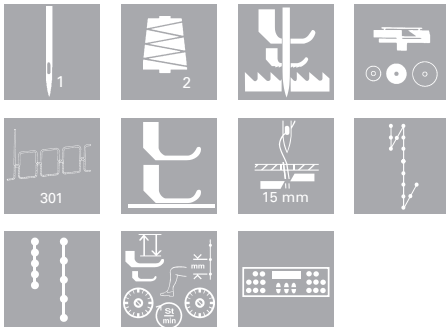



## Two-thread chainstitch high-speed seamer with drop feed

- Optimum sewing reliability, even at max. speed
- Low-noise, low-vibration running
- Very good feed characteristics at low foot pressure
- Infinitely variable stitch length

### Typical field of application

- Making up belt loops

### Specifications

- Max. sewing speed: 6,000 s.p.m.
- Max. stitch length: 4.5 mm
- Needle gauge: 4.5 and 6.0 mm

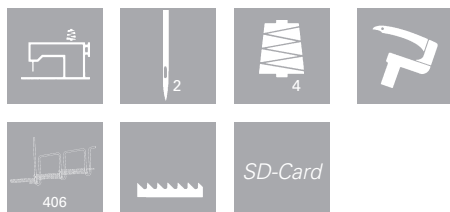



## Two-thread chainstitch high-speed seamer with differential bottom feed (double-lap seam)

- Pedal-operated bottom-feed control for changing the differential feed stroke during the sewing action
- The bottom feed can be set for stretching or gathering the lower fabric ply
- Stitch length regulator with integrated differential-feed control levers
- PFAFF 5489-H: Two needles or three needles
- Special version: Parallel-working differential feed (-739/01) and puller feed (-748/26) used for efficient and distortion-free sewing of left-hand lap-felled seams

### Typical field of application

- Sewing of lap-felled seams and yoke seams by jeans

### Specifications

- Max. sewing speed: 5,500 s.p.m.
- Max. stitch length: 4.5 mm
- Clearance under presser foot: 7.0 mm







## Double-chain-stitch special high-speed seamer in single and multi-needle models with bottom and needle feeds

- The hooks are arranged parallel to each other and work in the seam line (INLINE).
- Precise and even stitch-setting on all materials.
- Simplified threading due to the retractable hook; all threading points are accessible from the front of the machine.
- Can be equipped with up to 10 needles next to each other.
- Other needle gauges and seam constructions are possible by conversion.
  - largest gauge between outermost needles 60 mm
  - smallest gauge between two needles 4.8 mm
- By exchanging mechanisms or sewing tools the machine can be adapted to suit individual needs.
- The construction is suitable for table-height and standing installation.

### Typical field of application

- General sewing operations on jeans, workwear, sportswear, casual wear and other goods

### Specifications

- Max. speed: 3,600 s.p.m.
- Stitch length (max.): 1-needle: 8.5 mm, multi-needle: 6.0 mm
- Needle gauge: 4.8 - 60.0 mm (Special version: 3.2 mm, only 2- and 3-needle)





## Unison feed chainstitch special sewing machine for high-quality top-stitching operations on heavy fabrics

- Very high stitch quality for top stitching and decorative seams
- High traction due to unison feed (Bottom feed and alternating top and needle feed)
- A detachable work plate ensures a simple conversion from free-arm to flatbed
- The 5626 work with parallel located loopers which move in sewing direction (Inline)
- Simple threading, owing to swing-out loopers. All threading points are accessible from the front of the machine.
- High top feed stroke; max. 7 mm
- Fabric clearance under the foot: max. 14 mm
- Further fittings on request

### Options

- Pneumatically actuated seam center guide
- Height adjustable stand for sit-down or stand-up operation
- Fully submerged set-up

### Typical field of application

- Fixing and top-stitching of the waistband (Jeans)

### Specifications

- Max. speed: 3,600 s.p.m.
- Stitch length (max.): 1-needle: 8.5 mm, multi-needle: 6.0 mm
- Needle gauges: 4.8 to 60 mm (Special version: 3.2 mm, only 2- and 3-needle)

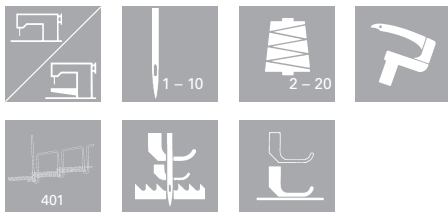



## CNC-controlled automatic lockstitch bartacker for medium-weight applications like jeans and workwear

- The optionally available conversion kit "Heavy" allows bartacking operations also in medium to heavy-weight materials
- Short cycle time for high efficiency through step-motor controlled clamp lift
- Oil-free machine head, material remains free of oil stains
- Needle thread clamp below the throat plate to secure the sewing start
- Thread trimmer for short thread ends, no separate trimming required
- Thread wiper for neat seam beginning
- Own stitch pattern transferred via USB-flash drive
- Stabiliser to balance electric voltage peaks

### Typical field of application

- Bartacking operations in jeans garments

### Performance features

- Sewing field size 40 x 30 mm
- 50 preprogrammed bartacks to choose from
- Memory capacity for 50 bartack variants
- 25 sequences each up to 30 bartack variants
- Bartack dimensions can be changed in mm
- Sewing speed max. 3,200 stitches/min.

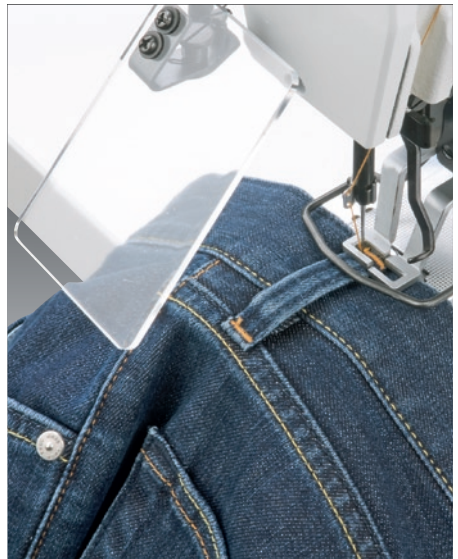
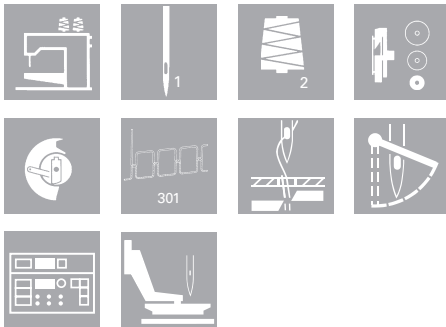



## Automatic double-chainstitch eyelet buttonholer with short thread trimmer specialized for maximum output

- High-quality control system of DAC comfort and Machine-ID
- Machine parameters can be copied by USBflash drive
- Saving of machine parameters in machine-ID; all parameters are retained after changing the control box
- Improved seam quality by optimized needle thread tension with self-monitoring function
- Use of long-life, electro pneumatic valves (regional sourcing – e.g. Asia)
- Short thread trimmer for needle thread, looper thread and gimp thread (in case of round eyelets the bobbin thread is cut manually)
- Gimp thread control (optional)
- Double stitching function for buttonholes
- Sewing equipment with special upper fabric clamps to sew buttonholes in trousers waistbands (= according to sewing equipment)

### Typical field of application

- Eyelet buttonholes and double-chainstitch round eyelets in trousers, jeans, sportswear and workwear

### Performance features

- Cutting length 10 – 32 mm\*
- Diameter of round eyelets 1 – 5 mm\*
- Max. sewing speed 2,500 stitches/min.

\* according to sewing equipment

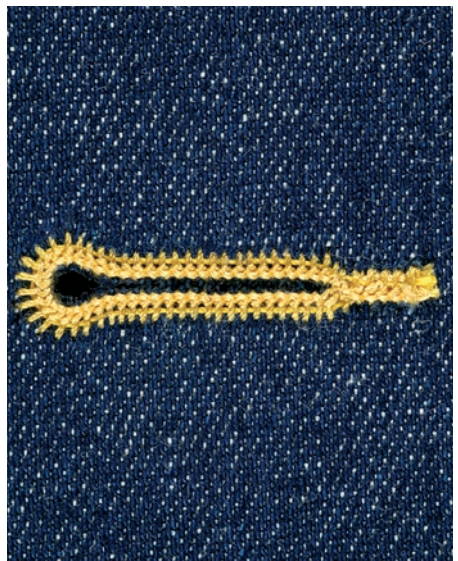
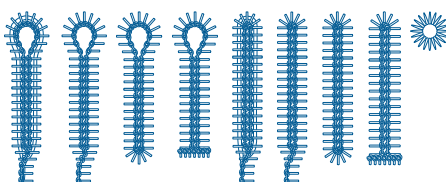
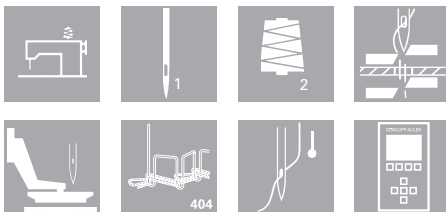



## Automatic double-chainstitch eyelet buttonholer with innovative Multiflex cutting system, specialized for maximum output

- High-quality control system of DAC comfort and Machine-ID
- Machine parameters can be copied by USBflash drive
- Saving of machine parameters in machine-ID; all parameters are retained after changing the control box
- Improved seam quality by optimized needle thread tension with self-monitoring function
- Use of long-life, electro pneumatic valves (regional sourcing – e.g. Asia)
- Short thread trimmer for needle thread, looper thread and gimp thread
- Different buttonhole shapes and lengths without change of cutting tools
- Gimp thread control (optional)
- Double stitching function for expressive buttonholes with thin thread sizes

### Typical field of application

- Buttonholes and round eyelets in uniforms, sportswear and casual wear

### Performance features

- Cutting length 10 – 32 mm\*
- Diameter of round eyelets 1 – 4 mm\*
- Max. sewing speed 2,500 stitches/min.

\* = according to sewing equipment

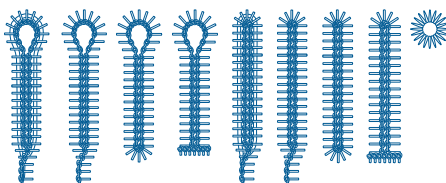
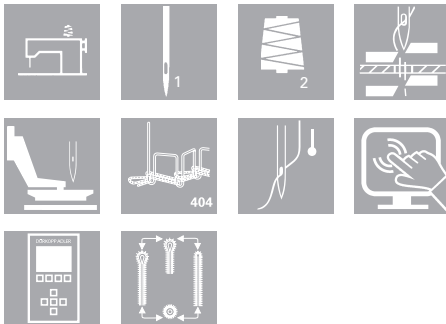



## Eyelet buttonhole indexer for small parts as e.g. jeans fly pieces

- Indexer MA 10 for sewing buttonholes in various individually adjustable sequences
- High-quality control system of DAC comfort and Machine-ID
- Machine parameters can be copied by USB flash drive
- Saving of machine parameters in machine-ID; all parameters are retained after changing the control box
- Use of long-life, electro pneumatic valves (regional sourcing – e.g. Asia)
- Short thread trimmer for needle thread, looper thread and gimp thread (in case of round eyelets the bobbin thread is cut manually)
- Gimp thread control (optional) to increase production and secure quality
- Double stitching function for expressive buttonholes with thin thread size

### Typical field of application

- Sewing eyelet buttonhole in jeans fly pieces

### Performance features

- Max. sewing area 110 mm
- Cutting length 10 – 32 mm \*
- Max. sewing speed 2,500 stitches/min.

\* = according to sewing equipment

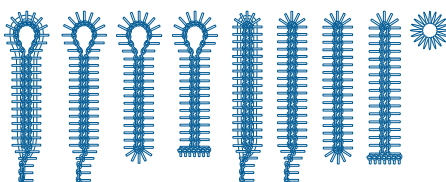
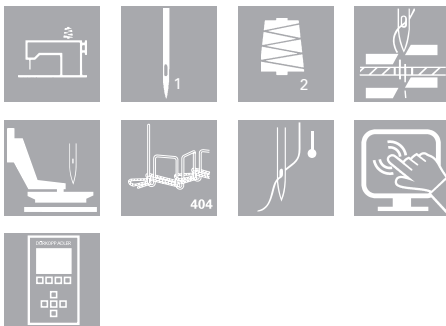
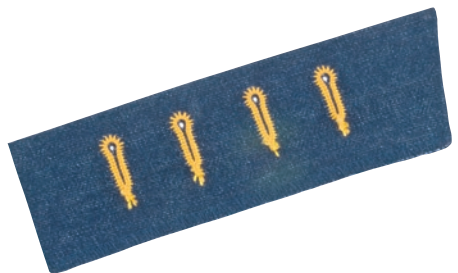



## Automatic sewing unit for run-stitching and cutting small parts in one step

- Constant high seam quality with the use of jigs
- Simple operation, short training times
- Application of fullness (option)
- Simple change to another size or a different article
- Free seam programming directly on the machine
- Overlapping production method with the use of sequence control unit
- High output owing to the overlapped work method with the use of two sewing jigs
- S3 control panel with integrated data reader (SD-card) for importing sewing programs or machine software

### Typical field of application

- For simultaneous run-stitching and trimming small parts such as flaps, waistband extensions, shoulder flaps, cuffs etc.

### Specifications

- Max. speed: 3,000 s.p.m.
- Needle system: 134 KK
- Output in 8h: 1,600 flaps

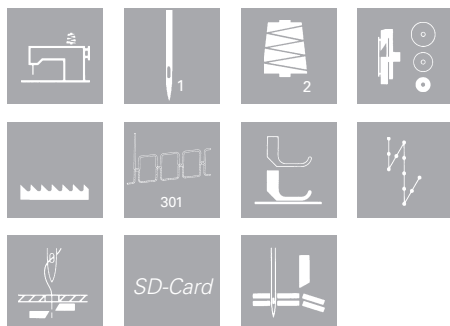

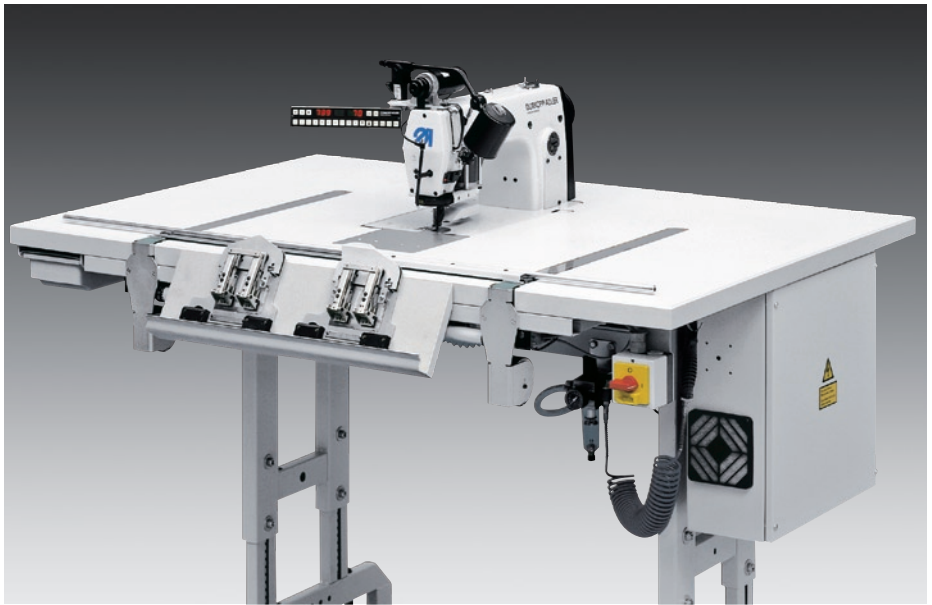

## Runstitching flaps

- Perfect seam courses and accurate repetition by means of sewing templates
- Freely programmable TAGLOG® chip for storing seam course, sewing speed, stitch length and bartack length
- Sets of parts for the self-manufacture of templates available
- Perfectly distributed fullness due to fullness bow on the template
- Constant seam distances and clean edge cutting by means of separately driven edge trimmer
- Lockstitch machine for tight seams, with stitch condensing even in corners and radii

### Typical field of application

- Runstitching small parts like flaps

### Performance features

- 2,000 – 2,400 flaps / 480'

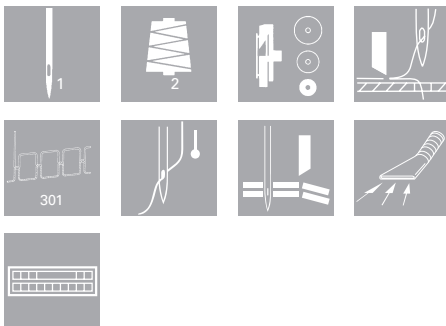





## Engineered workplace to attach waistbands

- Basic machine to process waistbands for jeans and work clothes using the "cut-to-size"-method
- The proven PFAFF 5626 chainstitch inline forms the core of this work station
- The customized sewing kits in combination with the unison feed ensure the reliable feed of the waistband and the trousers
- Due to the compensating presser foot the variable number of cloth layers ranging from 2 to 5 or more are reliably transported and sewn even without a puller
- The threads are cut by a separate hook knife behind the arm
- Stand for stand-up operation

### Options

- Customized sewing kits
- Customized attachments

### Typical field of application

- Fixing and top-stitching of the waistband (Jeans)

### Technical Data:

- Max. sewing speed: 3,600 s.p.m.
- Max. stitch length: 4.5 mm:
- Needle gauge 32.0, 34.8, 36.00, 38.00 mm
- Option: 6.4 x 25.4 x 6.4 mm
- Multi-needle versions: minimum needle gauge 4.8 mm

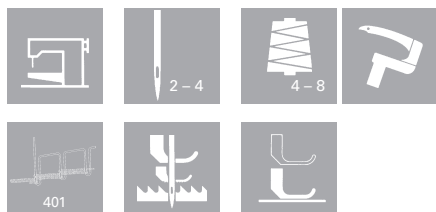



## Integrated work station to attach automatically the waistbands

- Automatic attachment of waistbands to jeans and work clothes using the "waistband-material-from-the-bobbin"-method
- The PFAFF 5622 chainstitch inline forms the core of this work station
- The customized sewing kits in combination with the puller feed ensure the reliable transport of the waistband together with the trousers
- The entire sewing and cutting cycle may be programmed: protrusion of the waistband, skipped stitches, start and stop of the waistband
- By exchanging the rollers, the divided puller permits the production of women's jeans (curved waistbands) and men's jeans (straight waistbands)
- Single column stand for stand-up operation

### Options

- Customized sewing kits
- Customized attachments

### Typical field of application

- Fixing and top-stitching of the waistband (Jeans)

### Technical Data

- Max. sewing speed: 4,000 s.p.m.
- Max. stitch length: 4.5 mm:
- Needle gauge: 32.0, 34.8, 36.00, 38.00 mm
- Option: 6.4 x 25.4 x 6.4 mm
- Multi-needle versions: minimum needle gauge 4.8 mm





## Pocket hemmer

- High productivity and constant sewing quality for pockets with straight or slanted openings
- Very simple operation (only feed the pocket blanks into the machine)
- A newly designed band feed, driven by a stepper motor and optimized transport belts allows the universal processing of assorted materials and material thicknesses
- Inserting station (+ photocell control) with automatic start
- Smooth and absolute straight pocket hem via optimized hemming device with supporting transport
- Automatic chain cutter and suction mechanism
- High performance: approx. 16,500 pockets in 8 hours
- Wide range of application, e. g. surf shorts, all denim fabrics (even stretch), standard pockets, watch pockets, pockets on work pants.
- Stand for stand-up operation
- Customized sewing kits + attachments (Option)
- Thread monitor (Option)

### Typical field of application

- Hemming of pockets

### Specifications

- Max. sewing speed: 4,000 s.p.m.
- Max. stitch length: 4.5 mm
- Needle gauge, standard: 6.4 mm
- Needle gauge, option: 3.2 mm, 4.8 mm, 7.2 mm, 8 mm, 9.6 mm, 12.7 mm
- Multi-needle version: 3-Needle: 3.2 x 3.2 mm





## Integrated workstation to attach belt loops

- High productivity and easy servicing
- Sewing head: PFAFF 2-needle bartacker (lockstitch)
- Length-cutting equipment for the belt loops
- Detection for the loop start and removal
- Loop feed with folding device
- Simple adjustment of the loop lengths
- Ergonomically designed handling for the operator
- Electr. bobbins to wind with steady thread tension
- Optimized cycle time to tack both ends (standard tack approx. 1.2 sec. with 28 stitches).
- Due to the XXL-hook there is minimum down time
- Height-adjustable stand for stand-up operation

### Options

- V-cut kit
- Thread monitor, needle cooler

### Typical field of application

- Automatic attachment of belt loops to jeans, work trousers and sports apparel

### Specifications

- |                              |                   |
|------------------------------|-------------------|
| ■ Max. sewing speed:         | 3,000 s.p.m.      |
| ■ Stitch length:             | 0.1 up to 12.7 mm |
| ■ Needle size:               | Nm 110 - 120      |
| ■ Needle gauge:              | 20 up to 80 mm    |
| ■ Belt-loop length finished: | 40 up to 85 mm    |
| ■ Belt-loop width:           | 8 up to 25 mm     |
| ■ Tack length:               | 7 up to 30 mm     |
| ■ Tack width:                | 1 up to 3.5 mm    |

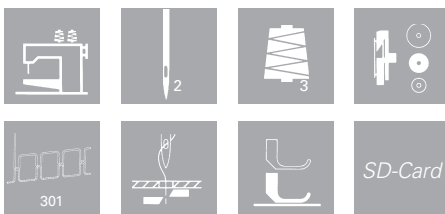

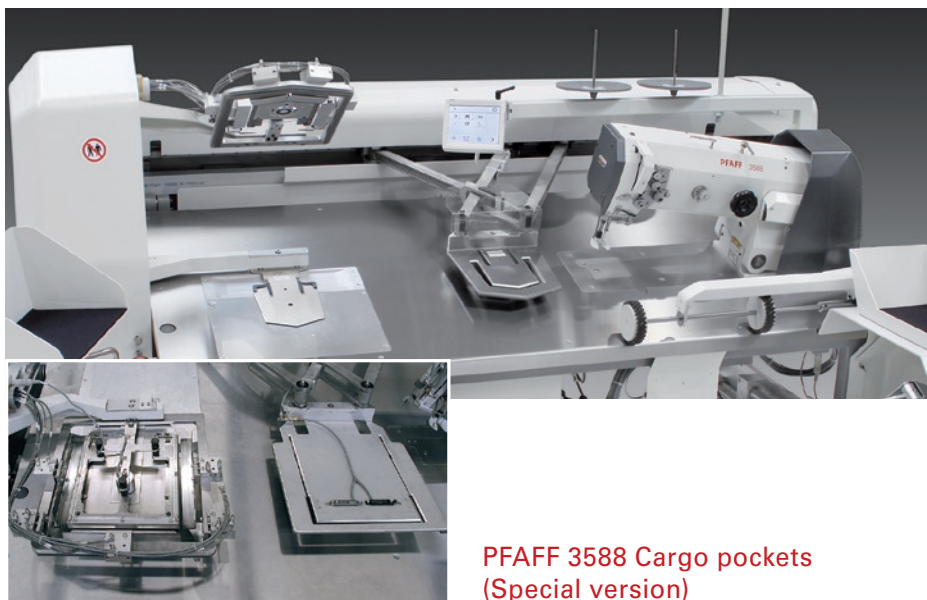

**PFAFF 3588 Cargo pockets  
(Special version)**

## Programmable automatic pocket setters for jeans and work wear

- The intermittent material feed guarantees feed stop when the needle enters the material and reduces hook wear to a minimum
- Touch-control-panel P1 with integrated SD card reader. The P1 guarantees an intuitive operation
- High sewing reliability and even seam quality, due to a special sewing head
- Seam programming and seam correction using the integrated machine control panel guarantee high flexibility
- Inexpensive conversion kit-versions (quickly and easily convertible) enable the use of this machine even for frequently changing pocket styles, or for the production of a smaller series
- Complete equipment can be adjusted in height by pressing a button (optional)
- Special version for bellow pockets

### Typical field of application

- Automatic creasing and attaching of pockets in jeans, workwear and sportswear

### Specifications

- Max. speed: 4,000 s.p.m.
- Size of sewing area:  
subclass -05/020      250 x 250 mm  
subclass -15/020      280 x 280 mm
- Output in 8h: 2,400 standard pockets

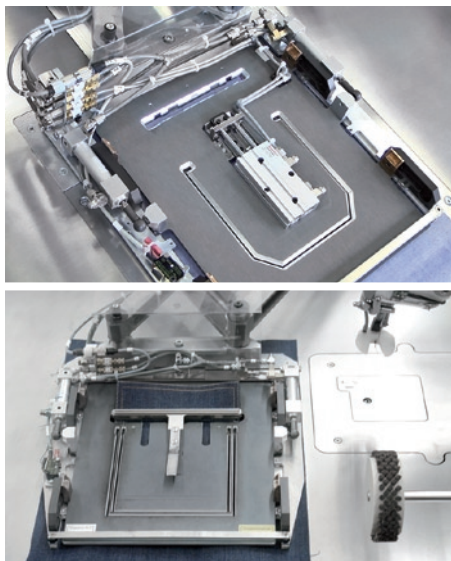



## Programmable automatic pocket setters with two machine heads

- Consistent high quality and high output - also when using two machine heads with separate colored threads
- Forms and templates may be easily interchanged within a few minutes
- Sewing head and hook (XL hook) are synchronized by the electrical axis
- The machine is equipped with an integrated folding station and a stacker
- Sewing programs can be created and modified on an usual PC (with special software)
- Sewing parameters can be changed via the touch control panel
- Processing of pre-folded pockets is possible
- Decorative stitches are also possible (using one or two heads)
- On customer request: watch pocket version
- USB-port to download programs and software updates
- Performance: 2,600 medium sized pockets with 350 stitches in 8 hours (single-needle)

### Typical field of application

- Automatic creasing and attaching of pockets in jeans, workwear and sportswear

### Specifications

- Max. speed: 4,000 s.p.m.
- Size of sewing area: 300 x 300 mm
- Stitch length: 0.05 - 12.7 mm
- Connection voltage: 380 V

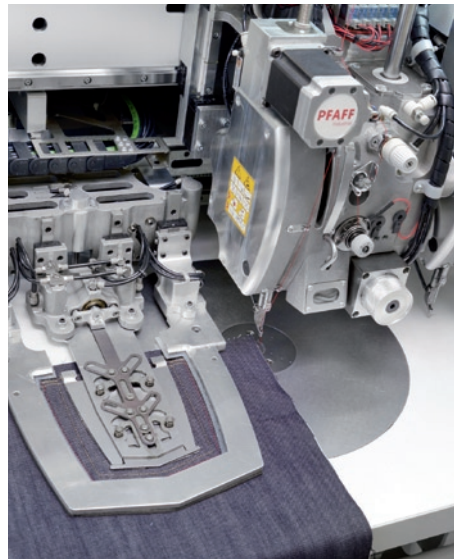



## Sewing unit for automatic creasing and attaching of pockets in jeans and workwear

- Maximum efficiency due to automatic creasing, attaching and stacking
- Fully overlapped work cycle
- Easy operation and short training times
- Touch panel PC with software ("DACAD") for the creation and modification of flexible seam programs
- Exact seam contour due to fine adjustment of the seam programs (creasing, corner and tack stitches) directly at the sewing unit
- Sequences for the alternate processing of the right or left pocket possible
- International user languages can be selected
- Seam programs (can be transferred via USB)
- Ergonomic workplace (alternatively for sitting or standing operation)

### Typical field of application

- Automatic creasing and attaching of pockets in jeans, workwear and sportswear

### Performance features

- approx. 1,800 pockets (with double seam and bartack) / 480'

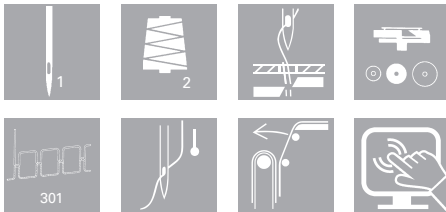



## Sewing unit for attaching of precreased jeans pockets

- High bobbin thread capacity by XXL vertical hook (Ø 32 mm)
- Thread breakage identification with automatic sewing stop and monitoring of the bobbin thread capacity by thread consumption control
- Electromagnetic thread clamping device for neat seam beginning
- Large bobbin thread capacity due to XXL vertical hook (Ø 32 mm)
- Quick and easy change of pocket shapes
- Low-priced pocket style sets, short amortization time
- Approved, robust M-TYPE sewing technology with large hook
- Quick seam change by means of DACAD software, simply transferable by USB stick
- Sewing thread size up to Nm 15/3 max.
- Max. sewing field size 210 x 210 mm
- Max. sewing speed up to 3,000 stitches/min.

### Typical field of application

- Jeans, workwear and sportswear

### Performance features

- approx. 1,800 pockets (with double seam and bartack) / 480'

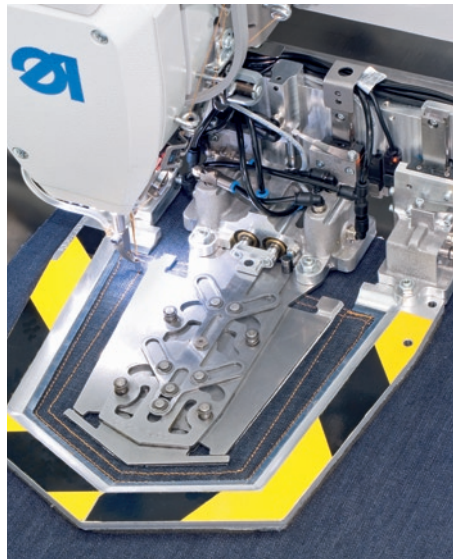
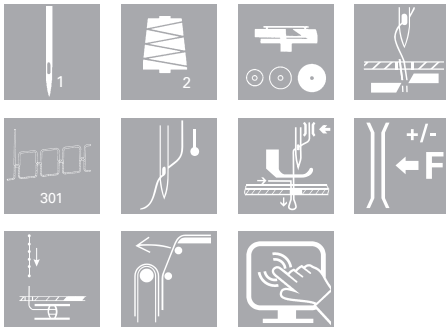





## Pocket creaser for pre-folding of pockets prior to further processing on the pocket setter 906-01

- Pocket cuts are created as per customerspecific shape – the pocket is permanently fixed by exposure to temperature and pressure
- For light- to medium-weight jeans and stretch materials from 8 oz to 14 oz. with cotton 80%, polyester 12% and elastane up to 8%
- Optional a deposit tray (9499 000005) or a deposit tray with cooling station (9499 000006) can be ordered
- The cooling station extracts the heat of the pocket for a better preservation of the fold (especially recommended for fabrics with more than 5% elastane)
- Semi-finished sets of parts for the self-manufacture of the creasing set optionally available
- Very short heating times
- High productivity by pressing 2 keys once with both hands for creasing and pre-folding hem corners
- Conversion time for changes of pocket shape approx. 10 minutes

### Typical field of application

- Creasing and pressing of jeans pockets

### Performance features

- approx. 2,500 jeans pockets / 480'





## Pocket creaser for pre-folding of pockets prior to further processing on the pocket setter 906-01

- Pocket cuts are created as per customerspecific shape – the pocket is permanently fixed by exposure to temperature and pressure
- For medium-weight jeans fabrics, mainly of cotton 95%, polyester 5% (without elastane), from 10 oz to 14 oz
- Short heating times
- High productivity by pressing 2 keys twice with both hands for creasing and pre-folding hem corners
- Conversion time for changes of pocket shape approx. 10 minutes

### Typical field of application

- Creasing and pressing of jeans pockets

### Performance features

- approx. 1,700 jeans pockets / 480'





## Single head overlock units for serging of jeans

- Serging with 9.6 mm throw width
- Constant sewing results
- Regular seam widths by means of accurate edge guiding
- High sewing speed
- High productivity through overlapping working
- Short instruction times due to easy handling
- High application flexibility
- Freely programmable seam sequences

### Typical field of application

- Serging of long seams in jeans

### Performance features

- Serging front and hind trousers  
(8 seams per trousers) = 700 – 800 trousers / 480'

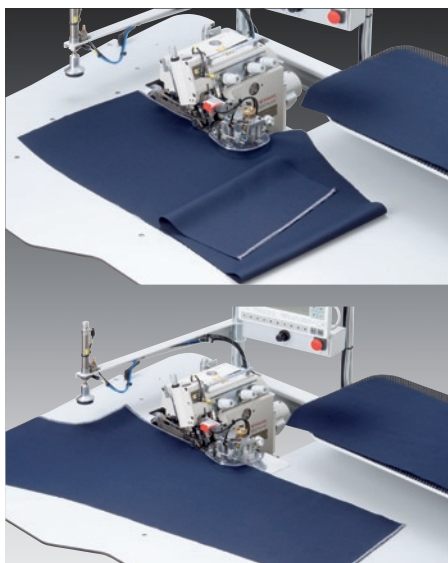
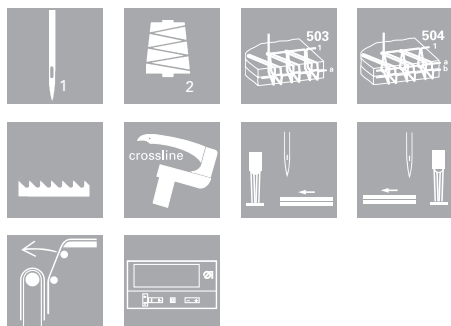



## Semi-automatic sewing of jeans side seams and inseams

- Sewing head EXT3216H for jeans applications available (optional)
- Touch screen with graphic display
- Maximum flexibility by use for double-chainstitch seams or 4-thread and 5-thread safety seams alternatively
- Perfect fit due to partial fullness distribution in the upper or lower material ply
- Automatic fullness distribution by pneumatically controlled top feed and bottom feed
- Step motor-controlled fullness distribution (optional)
- Equipment for manual sewing in the hip curve section when processing side seam pockets or wing pockets
- Pneumatically moveable edge guide for trimming the excess lengths of pocket bags in sportswear trousers

### Typical field of application

- Classical trousers and skirts
- Sportswear trousers

### Performance features



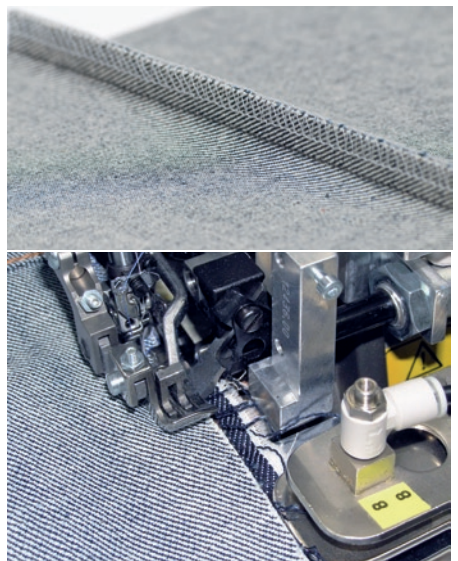









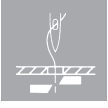





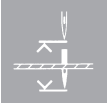











- 1,550 – 1,700 side seams / 480'
- 1,700 – 1,900 inseams / 480'
- 380 – 400 complete trousers / 480'



# Technical Symbols

	Dark Grey: Standard Equipment		CB hook
	Light Grey: Optional Equipment		Chain stitch looper
	Flat bed sewing machine		Butterfly hook
	Post bed sewing machine		Beak shuttle
	Monobloc sewing machine		Drop feed
	Raised flat bed sewing machine		Top feed
	Cylinder bed sewing machine		Compound feed
	Stitch type		Differential bottom feed
301			Bottom feed and variable top feed
	Number of threads		Differential bottom feed and variable top feed
	Number of needles		Bottom feed and alternating top feed
	Bight width		Unison feed
	Vertical hook, small		Puller feed
	Vertical hook, large		Bottom- and puller feed
	Extra-large vertical sewing hook		Differential bottom feed and puller feed
	Horizontal hook, small		Bottom feed, needle- and puller feed
	Horizontal hook, large		

# Technical Symbols

	Roller presser (not driven)		Thread nipper device
	Roller presser (driven)		Thread trimmer
	Wheel feed, roller presser (not driven)		Thread chain cutter
	Wheel feed and driven roller presser		Tape- and chain cutter
	Wheel feed and needle feed (non driven roller presser)		Automatic needle positioning
	Wheel feed, driven roller presser and needle feed		Disengagable right or left needle
	Edge trimmer		Backtacking system
	Horizontal edge trimmer. Driven from below		Stitch condensation
	Horizontal edge trimmer. Driven from above		Automatic presser foot lift
	Horizontal edge trimmer. Driven from above		Top feed lift adjustable by knob
	Feathered trimming		Automatic roller presser lifter
	Under-edge trimmer		Top Bobbin thread monitor via sensor
	Control for two different stitch lengths		Bobbin thread monitor via sensor
	Horizontal edge trimmer		Bobbin thread monitor via stitch counter
	Thread wiper		Electronic control
	Sensor control		Sensor control

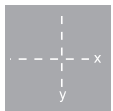

X -Y drive



Thread tension control



Electronical thread tension control



Small part stacker



Large part stacker



Bundle clamp



Program control, operating panel with color graphic display and touch screen

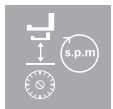

Top feed lift preselctable and recallable by knuckle switch, with automatic speed limitation



Thread nipper for a neat seam beginning

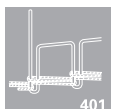

Double-chainstitch



Zigzag double-chainstitch



Overlock chainstitch, two threads, stitch type 503

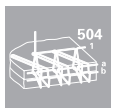

Overlock chainstitch, three threads, stitch type 504



Looper, crossline

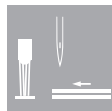

Reflecting light barrier for automatic sewing start at fabric beginning

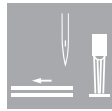

Reflecting light barrier for automatic sewing stop at fabric end



Bobbin capacity counter for bobbin thread

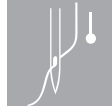

Needle thread monitor



Fullness, above, flat sewing, fullness, below



Underbed thread trimmer and thread trimmer above the throat plate



Thread trimmer and seam backtacking, automatic



Programmable thread tension



Quick stroke adjustment adjustable by dial activated by knee switch - with simultaneous speed limitation according to the foot stroke and feeding length

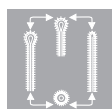

Multiflex cutting system

**PFAFF Industriesysteme  
und Maschinen GmbH**

Hans-Geiger-Straße 12  
67661 Kaiserslautern, Germany  
Phone +49 (0) 6301 3205-0  
Fax +49 (0) 6301 3205-1386  
info@pfaff-industrial.com  
www.pfaff-industrial.com

**Dürkopp Adler AG**

Potsdamer Str. 190  
33719 Bielefeld, Germany  
Phone +49 (0) 521 925-00  
Fax +49 (0) 521 925-2646  
info@duerkopp-adler.com  
www.duerkopp-adler.com

BEISLER - a brand of Dürkopp Adler AG

Impressum/Imprint:  
Publisher: PFAFF Industriesysteme und Maschinen GmbH  
Copyright © PFAFF Industriesysteme und Maschinen GmbH, 2016

Subject to design changes · Part of the machines shown with additional  
equipment · Printed in Germany · No. 296-12-19326  
All rights reserved · Reproduction or publication - even in extracts -  
is prohibited without prior written permission  
of PFAFF Industriesysteme und Maschinen GmbH

